



C-MP76-01

Impresora Matricial de Impacto

Contents

Security Notes	3
Packing (Printer & Accessories)	3
Features.....	4
Specifications.....	5
Connection	6
Paper roll & ribbon loading	6
Setting printing Mode (DIP Switches)	7
DIP switch functions.....	7
Light Indicators:.....	8
Driver installation	9
METHOD 1: Installing WINDOWS drivers:.....	9
METHOD 2: Printing to port directly.....	13
Troubleshooting	14

Security Notes

- Place the printer on a flat surface. Choose firm, level surface, avoid vibration.
- Don't use and store the printer in high temperature, high humid or polluted place.
- Connect power adapter properly to grounded receptacle. Avoid using the same socket with large power consumption devices that can lead to the power fluctuation.
- Avoid water or other objects go into printer. Once happened, turn off printer immediately. Print without paper roll will damage the printer head seriously.
- Unplug printer from power receptacle if it will not be used for a long time.
- Only use approved accessories, never try to disassemble, repair or remodel it yourself.
- Use only original power adapter.
- Use high quality paper, this ensures the printing quality and printer life.
- Turn off power before plug/unplug power cable.
- This printer must be used only under 5000 meters

Packing (Printer & Accessories)

- User Manual
- Printer
- Power Cabler
- Power Adapter
- Paper Roll
- Driver

Features

- High quality printing
- Low- noise and high-speed printing
- Includes cash drawer driver
- Support black mark orientation
- USB, LAN interface optional
- Built-in data buffer (Able to receive new data while printing)
- Characters can be enlarged, adjusted line spacing, left and right spacing, as well as bold and under line Equipped with paper source sensor, Loading paper and detection automatically
- Support different density NV bitmap download and printing Support server printing
- ESC/POS compatible, setting DIP switch to choose characters and fonts Through software binding to set printer identification
- Support international languages

Specifications

Printer Dimension	230mm (L) × 150mm (W) × 138mm (H)
Net Weight	1.46Kg
Printing Method	9 Pins Impact Dot Matrix
Printing Speed	4.5 Lines per Second
Resolution	84 dpi
Max Printing Width	63.5mm
Media Type	Paper
Paper Width	75.5± 0.5mm
Paper Thickness	0.06mm-0.085mm
Paper Roll Diameter	80mm (Max)
Paper Supply Method	Friction feed
Sensor	Paper end sensor, black mark sensor, cover open sensor
Drawer Port	1 Port - DC 24V
Memory	NV Flash 64K, Input Buffer 32K
Mechanism Print Life	10 Million lines
Interface	USB
Emulation	ESC/POS
Driver	Windows, Linux, Mac OS
Utility	Windows
SDK	Windows, Android
Power Supply Input	AC 110V/240V,50~60Hz (Adapter)
Power Supply Output	DC 24V/2.5A
Operating Temperature	0°C to 45°C
Operating Humidity	10~80%
Storage Temperature	-10° to 60°C
Storage Humidity	10~90%

Connection

- A. Connect AC power cord to power, DC power cord to printer.
- B. Connect printer and computer/ tablet.
- C. Connect cash drawer.

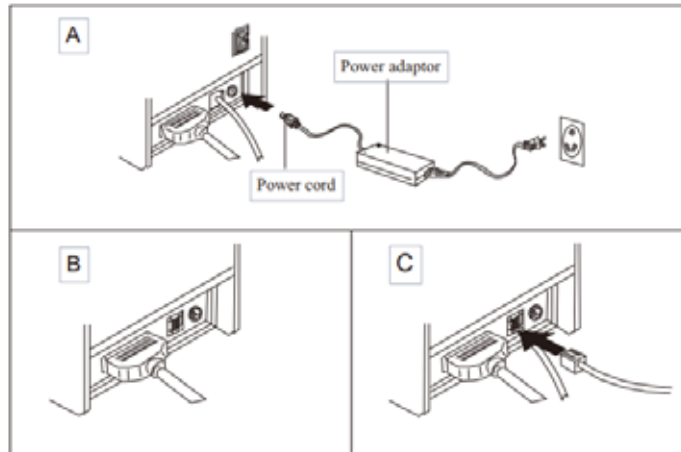

Paper roll & ribbon loading

- A. Turn on printer, open top cover.
- B. Load the paper roll as shown in the image.
- C. Hold both sides of roll paper and place it into paper-in entrance. The printer will finish feeding automatically.
- D. Tear off extra paper and close the cover.
- E. Open front cover, turning ribbon box knob for 5-6 laps as per arrow direction, insert ribbon as per below image. Push the ribbon box until clamping.

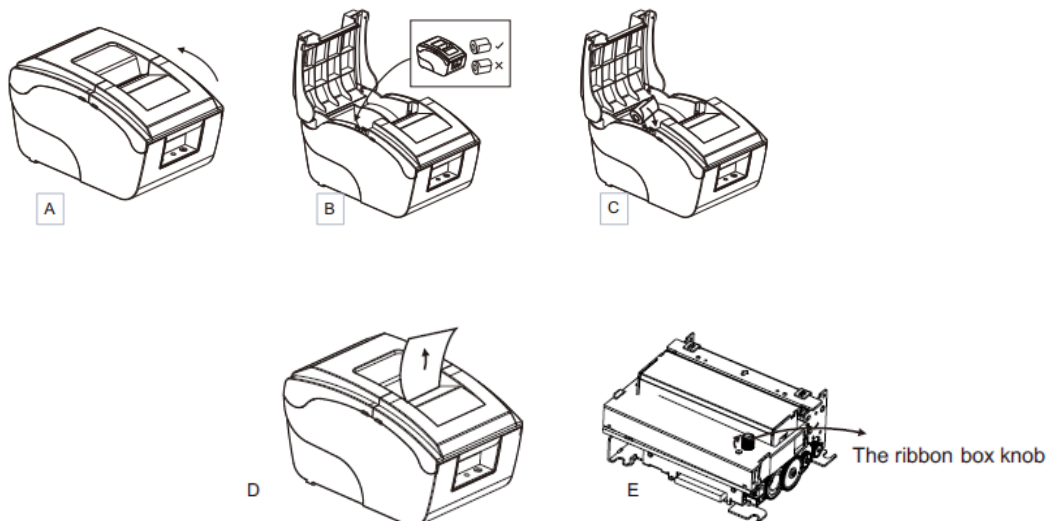

Setting printing Mode (DIP Switches)

DIP switches can be changed settings, such as: mark sensor, cutter, languages, beeper, print density baud rate etc.

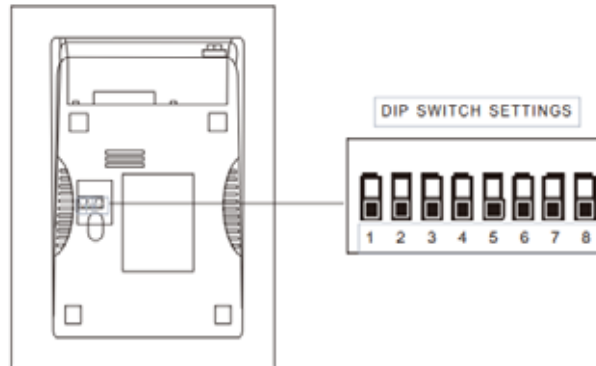

DIP switch functions

DIP Function				
NO.	Function	OFF	ON	
SW-1	Black mark mode	NO	YES	
SW-2	Select cutter	NO	YES	
SW-3	Cutter mode	Partial	Full	
SW-4	Unidirection	NO	YES	
SW-5	Two-byte code	YES	NO	
SW-6	Baud rate	9600	19200	
SW-7	Paper width 58mm	NO	YES	
SW-8	Char per line (in the following figure)			
SW-7	OFF	OFF	ON	ON
SW-8	OFF	ON	OFF	ON
Char per line(CPL)	40/33CPL	42/35CPL	30/25CPL	33/27CPL

Light Indicators:

Printer has two light indicators, [POWER] blue light and [STATUS] red light.

[Status] indicator light:

1. Red light for a long time: printer is ready.
2. Red light flashes rapidly and audible alarm sounds: printer out of paper.

[Power] indicator light:

Blue light indicates the printer is on

Self-test Method:

The printer must be connected to the power, keep it off, press the "FEED" button and turn on at the same time, 2 seconds later, release the "FEED" button, a complete self-test will print to show the printer settings.

Driver installation

Two methods:

1. Install driver directly.
2. Printing via port directly.

METHOD 1: Installing WINDOWS drivers:

1. Double click  driver

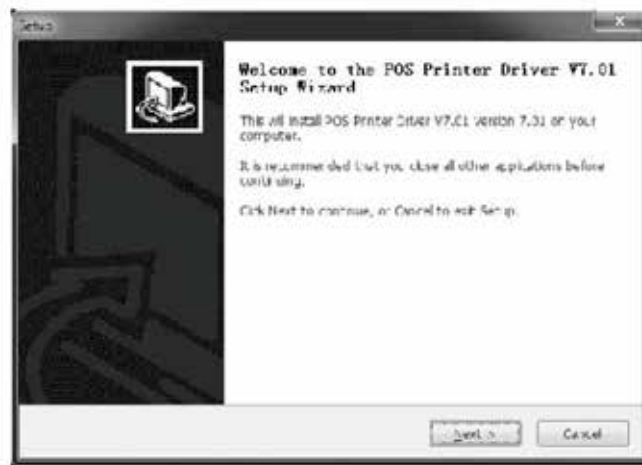

2. Select: I accept the License Agreement



3. Select Default Installation Folder

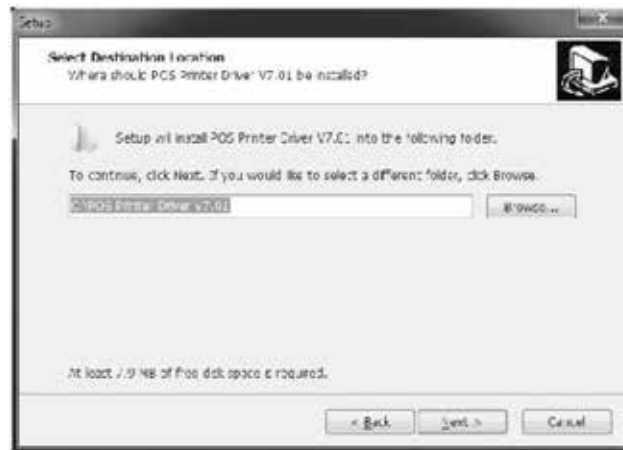

4. Create a shortcut on the desktop

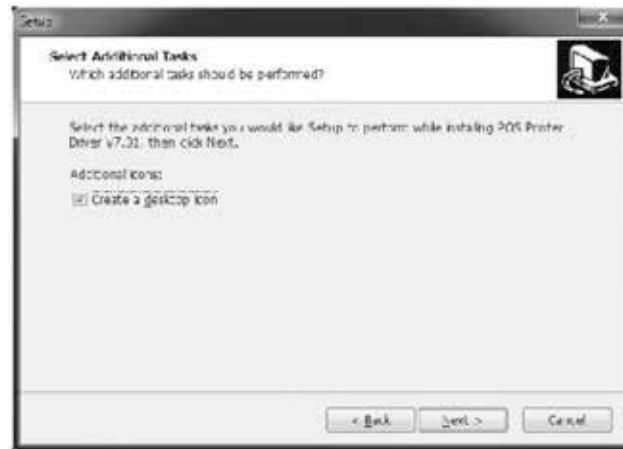

5. Install following instructions below



6. Finish



7. Select the port as shown below:

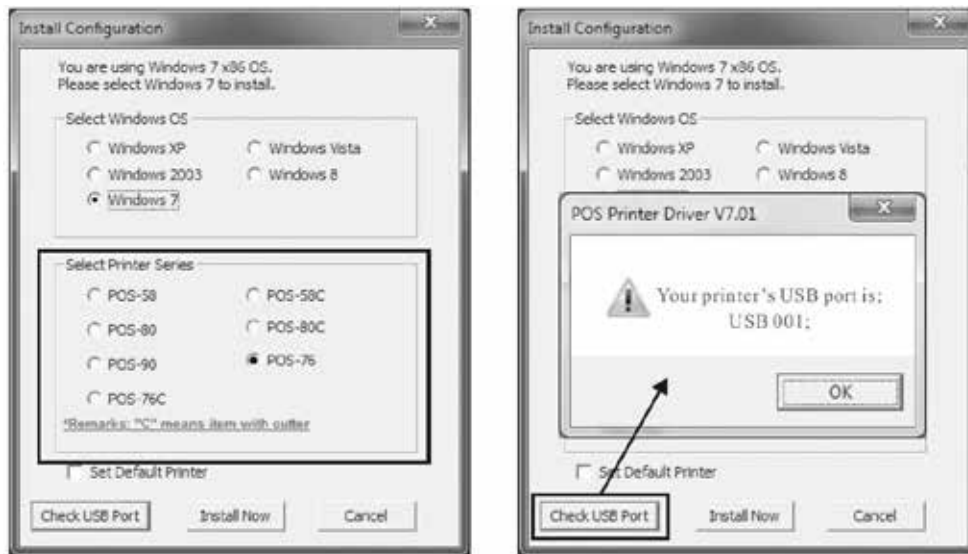

8. Select the series as shown below:

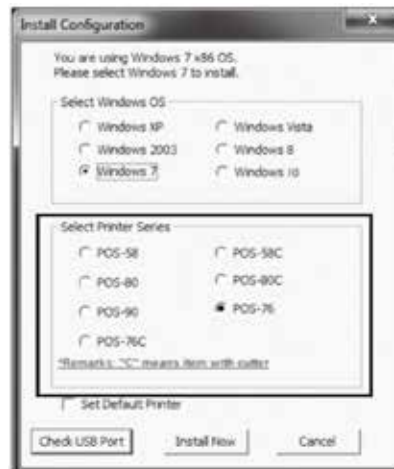

9. Click "OK" to configure the port



10. Select the detected USB001, click apply as shown below:



11. Select general and print test page

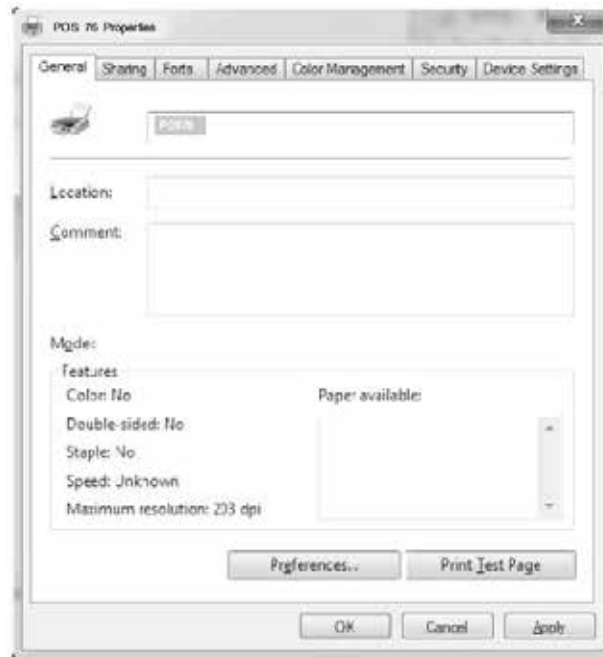

METHOD 2: Printing to port directly

- a. There is no need to install the printer drivers. Select the printer port (i.e., USB, LAN) in the application.
- b. Printing via port needs commands to control the printer, ESC/ POS commands are integrated directly itself.

Troubleshooting

If the printer has a problem, refer to this chapter to find a solution. In case the problem can't be solved, please contact your dealer or our technical support:

1. The indicator light of control panel does not work

Please make sure the power cord is well connected. Check if the power is on.

2. The STATUS indicator light twinkles, printer does not work.

(1) Turn off the printer and check if the paper is jammed.

(2) Printing head might be overheat after printer works for a very long time. It will continue to work after cooling down

(3) If the printer is neither jammed nor overheated, please turn off the printer, and re-start it 10 minutes later. If the printer still it doesn't work, unplug the printer immediately and contact with service technician.

3. The STATUS indicator light continuous bright, but printer doesn't work.

Print self-test page to check if the printer is working properly. If the printer can't print, please contact your dealer or service technician.

If printer isn't working normally, please check the following:

(1) Check if the printer is connected correctly to the computer

(2) Make sure the parameters of the printer match with the computer. You may refer to interface settings at self-test page. If the printer does not work, please contact your dealer or service technician.