

2C-LP427-B Guia de instalación

Quick Installation Guide

Printer overview

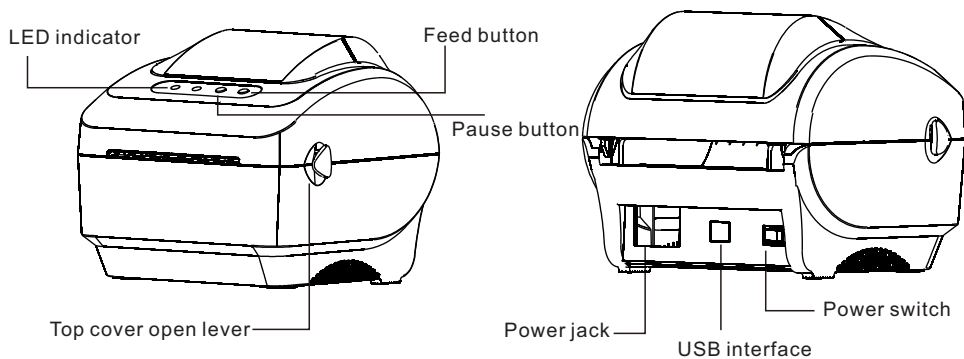

Note: The interface picture in the quick start guide is for reference only. Please refer to the product specification for the interfaces availability.

Printer Installation

1. Arrange this printer on a reliable flat surface and make sure the power switch is off.
2. Connect the printer to a computer mainframe with a USB cable.

3. Plug the power cord into the power jack connector at the rear of the printer, then plug the power cord into a properly grounded outlet.

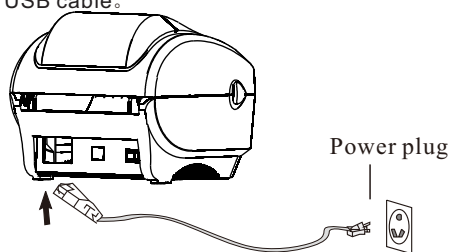

Note: Please switch OFF printer power switch prior to plug in the power cord to printer power jack.

Loading the label

1. Insert a 1" label spindle into a paper roll (* If your paper core is 1"inch, remove the 1.5" core adaptor from the fixed tab, use the label spindle directly).

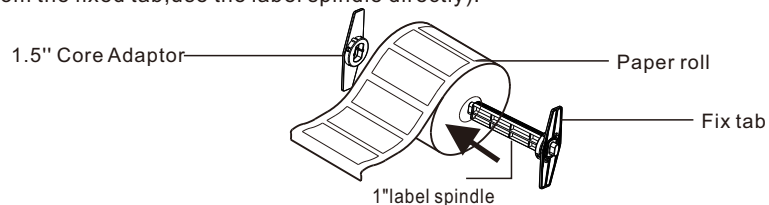

2. Open the printer top cover by pushing forward the top cover open levers.

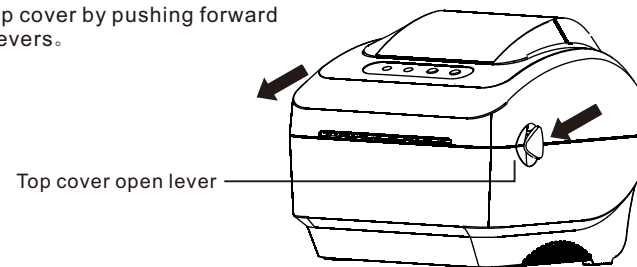

3. Orient a roll of paper on the paper roll mount, printing side face up.

4. Pass the label through the paper guide and pull the label over the rubber roller.

5. Toggle the label guide to the same width and slight contact with the label.

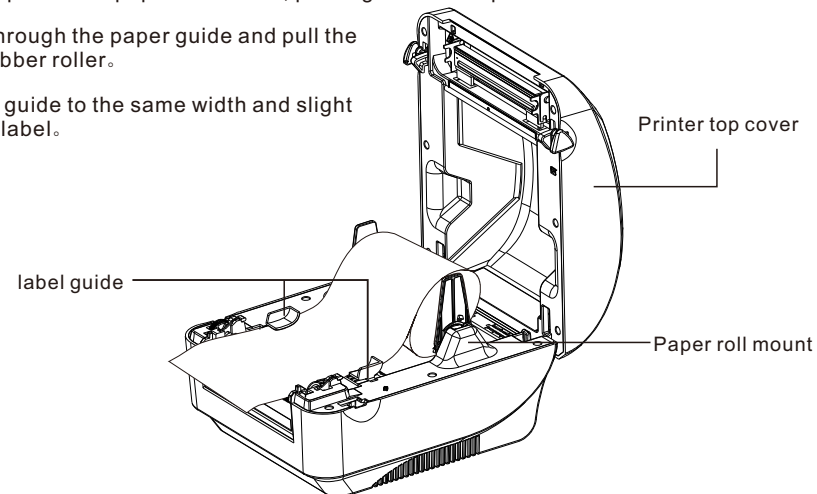

6. Close the printer top cover slowly and make sure the cover locks latch securely.

7. Use the "Diagnostic tool" to set the media sensor type and calibrate the selected sensor. (See "Diagnostic tool" and "Sensor Calibrate" in the next page).

Note:

1. Please calibrate the gap/black mark sensor when changing media.
2. Failure to securely close and lock the cover will result in poor print quality.

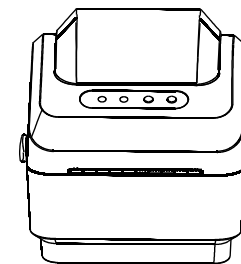

Button functions

(1) Feed labels

When the printer is ready, press the button to feed one label to the beginning of next label. When the printer reports an error, press the paper feed button and the print returns to normal.

(2) Pause button

When the printer is printing, press the button to pause a print job. When the printer is paused the LED will blink blue. Press the button again to continue the printing job.

Diagnostic Tool

The Diagnostic Utility is a toolbox that allows users to explore the printer's settings and status, change printer settings; download graphics, fonts, and firmware; create printer bitmap fonts, and to send additional commands to the printer. Using this convenient tool, you can explore the printer status and settings and troubleshoot the printer.

Note: This utility works with printer firmware V1.00 and later versions.

Start the Diagnostic Tool:

- (1) Double click on the Diagnostic Tool icon  Diagnostic Tool.exe to start the software.
- (2) There are 4 features (Printer configuration, File Manage ,Bitmap Font ,Command Tool, system printer settings) included in Diagnostic utility.

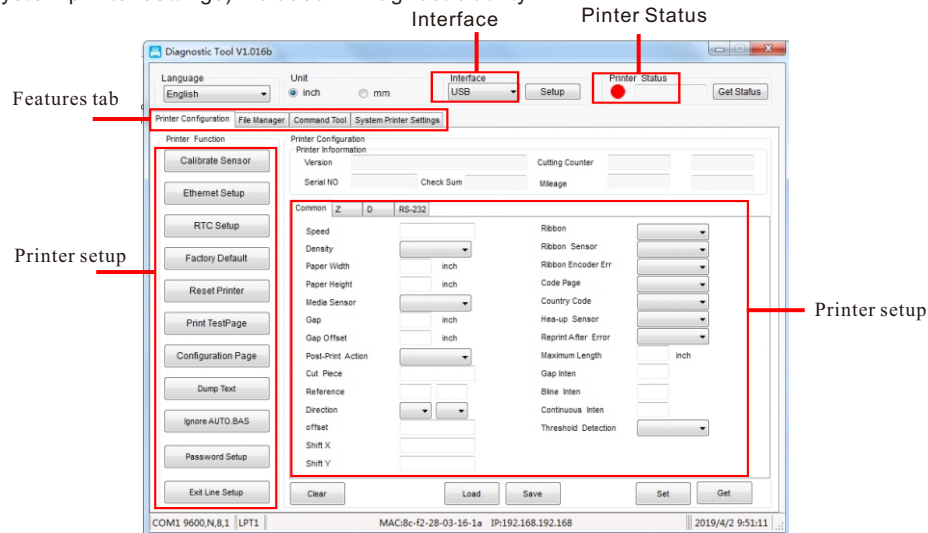

- (3) The detail functions in the Printer Function Group are listed as below.

Calibrate Sensor	Function	Description
Calibrate Sensor	Calibrate Sensor	Calibrate the sensor specified in the printer setup group media sensor field
Ethernet Setup	Ethernet Setup	Setup the IP address, sub net mask, gateway for the on board Ethernet
RTC Setup	RTC Time	Synchronize printer Real Time Clock with PC
Factory Default	Factory Default	Initialize the printer and restore the setting to factory default
Reset Printer	Reset Printer	Reboot printer
Print Test Page	Print Test Page	Print a test page
Configuration Page	Configuration Page	Print printer configuration
Dump Text	Dump Text	To activate the printer dump mode
Ignore AUTO.BAS	Ignore AUTO.BAS	Ignore the download AUTO. BAS program
Password Setup	Password Setup	Set Diag Tool password
Exit Line Mode	Exit Line Mode	Leave Line mode

Sensor Calibrate

1. Double click the icon  Diagnostic Tool.exe to start the “Diagnostic Tool” software.

2. Select the PC interface connected with bar code printer

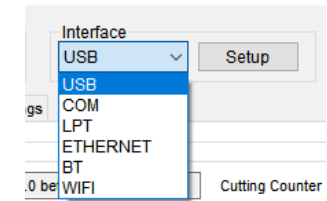

3. Click the “Calibrate Sensor” button to setting.

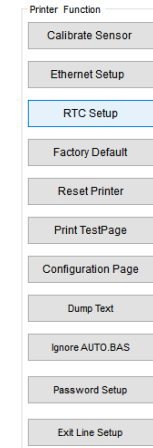

4. Select the media type (Gap/Black mark / Continue) and calibration type (Auto/ Manual) to calibrate the sensor specified in the printer setup group media sensor field. For the general media you only need to select the media type then click the “Calibrate” button.

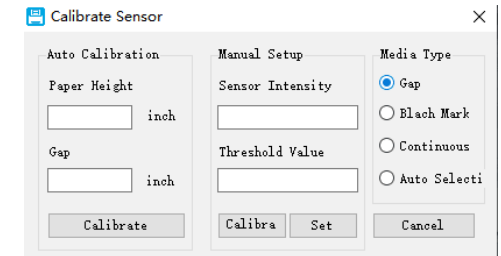

Note :

*For more information and features about this printer, please refer to the User's Manual inside the CD disk.

* Specifications, accessories, parts and programs are subject to the change without notice.